

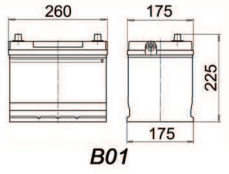







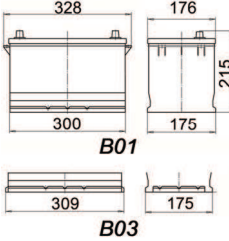

Fotografia della batteria Photo Photo de la batterie	Tipologia codice Type Code Typologie Code	Tensione Voltage Voltage	Capacità (20h) Capacity (20h) Capacité (20h)	Capacità (5h-10h) Capacity (5h-10h) Capacité (5h-10h)	Palletizzazione "E": Estero – "I": Italia Pallet "E": Foreign – "I": Italy PALLETISATION "E": Etranger – "I": Italie	Peso - Weight - Poids (± 0,5Kg)	Polarità–Tipo Poli Polarity-Terminals Polarité- Bornes	Schema - Fissaggio Drawing-Hold-Down Schéma-Fixation
 80Ah Special	D26 80Ah Special	12V	80Ah	60Ah(C ₅)	E-I:51/3	21,5	P:0 T:1	 B01
 105Ah Special	G28 105 Special	12V	105Ah	80Ah(C ₅)	E-I:42/3	27,2	P:0 T:1	 B01 B03
 Compact B Special	Compact B CB Special	12V	120Ah	100Ah(C ₁₀)	E-I:36/3	31,0	P:0 T:1	 B01 B00
 Compact A Special	Compact A CA Special	12V	150Ah	120Ah(C ₁₀)	E-I:24/2	40	P:0 T:1	 B00
 C Special	C 240Ah 740 025 120	12V	240Ah	190Ah(C ₅)	E-I:18/3	64,0	P:0/1 T:1	 B00
 UT 240	UT UT 240	6V	240Ah	190A(C ₅)	E-I:18/2	35,0	P:0 T:1	 B00

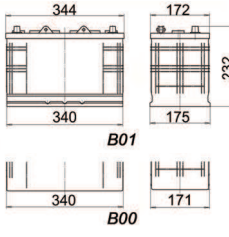
POLARITÀ – POLARITY – POLARITÉ

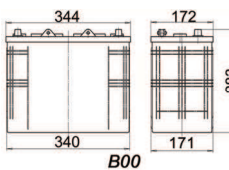

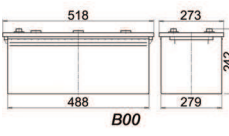
POLI TERMINALI – TERMINALS – BORNES

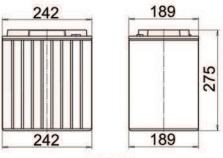
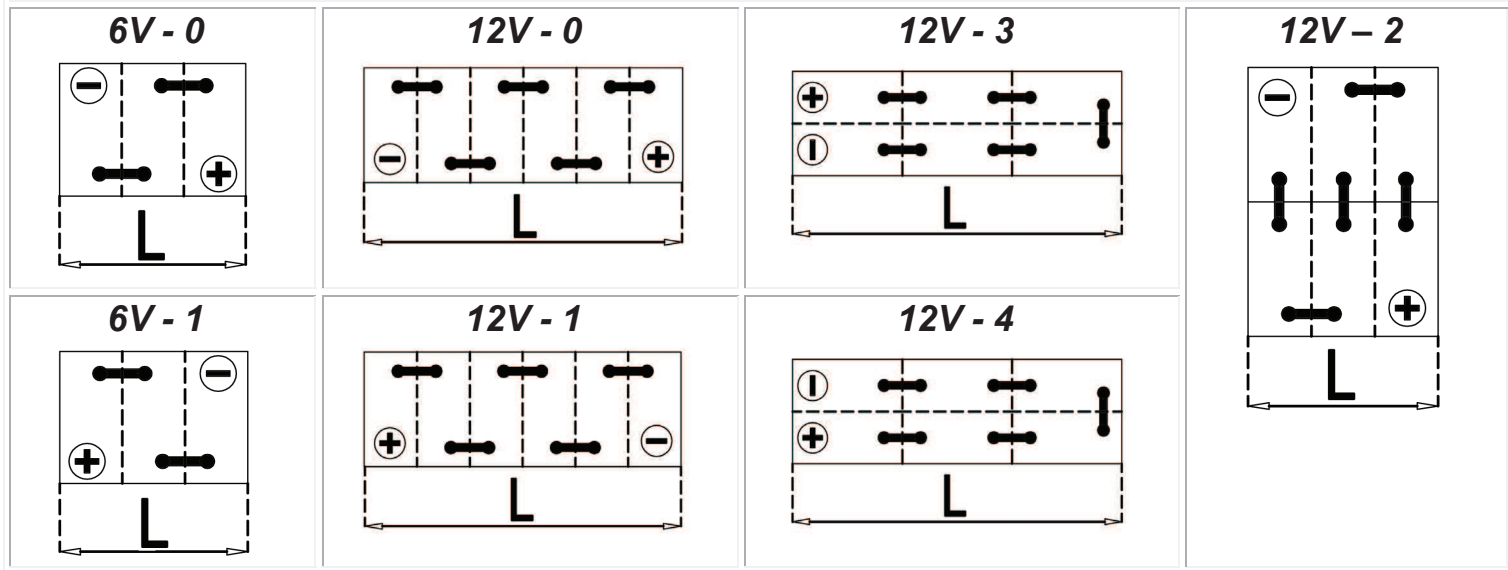
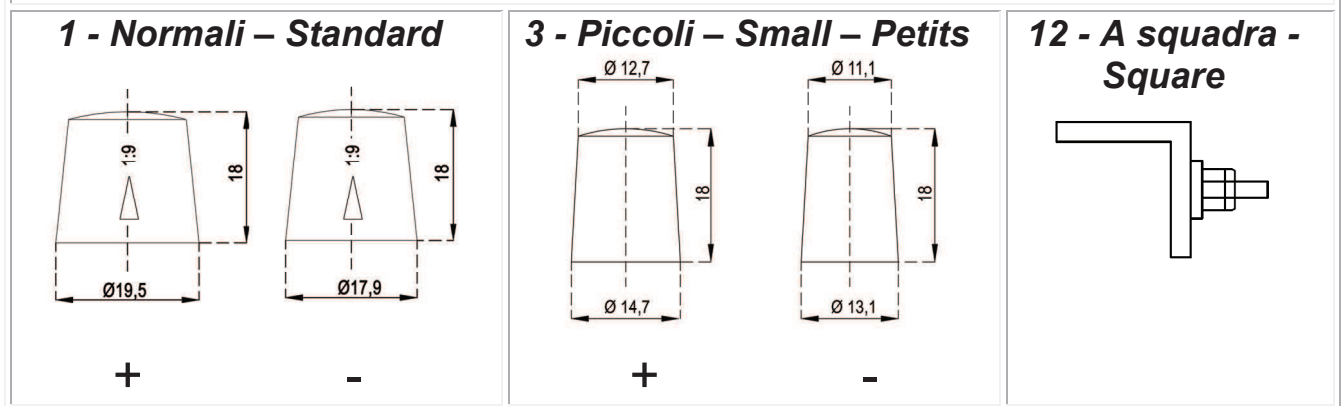

FISSAGGI ALLA BASE – HOLD DOWN – FIXATION

